User manual

VLM500-DG

Version 1.6



ASTECH
Angewandte Sensortechnik

Remarks

The information provided in the manual on hand have been carefully investigated and processed. Still, we cannot assume any kind of liability regarding completeness or mistakes. However, we are always grateful to get feedback and proposals.

Claims for damages are, except in the case of premeditation or negligence, in principle excluded.

As a series of versions of this product is available, deviations from the manual on hand might occur, if applicable.

We reserve ourselves the right to implement technical modification that serves to optimize of the product without related notification. Thus, it cannot be assumed that subsequent product versions show the same properties as the one on hand.

Registered trademarks are the manufacturer's property.

VLM500-DG – User manual V1.6

Copyright © ASTECH Angewandte Sensortechnik GmbH, Rostock 2018-2021

VLM500-Serie from Hardware version 2019, Firmware Version from V1.52R3

Date of printing: 17.05.2021

Revision history

Revision	Date	Changes
1.6	12.12.2023	Description of command "SYNCODO" changed Profinet-parameterization added
1.5	10.03.2021	Error codes changed Command "SYNCODO" added Chapter "Test mode" added
1.4	16.09.2020	First English release

ASTECH GmbH, Schonenfahrerstr. 5, D-18057 Rostock

Internet: www.astech.de E-Mail: info@astech.de

Telephone: +49 (0)381 / 44073-0 Telefax: +49 (0)381 / 44073-20

I. Table of contents

1	General information	5
1.1	Introduction	5
1.2	Mode of operation	6
2	Data transmission	10
2.1	Profinet	10
2.2	Ethernet	15
3	Programming	19
4	Test mode	24
5	Error messages	25
6	Device cabling	26
7	Wiring plan	27

II. Commands and parameters of the VLM500-DG

<i>Sync</i>	21
<i>Syncauto</i>	21
<i>Syncbasis</i>	21
<i>Synccalc</i>	22
<i>Synclength</i>	22
<i>Syncodo</i>	22
<i>Syncoutput</i>	22
<i>Syncrefresh</i>	23
<i>Syncstart</i>	23
<i>Syncstate</i>	23
<i>Syncstop</i>	23

III. List of figures

Figure 1: Principle of a skin pass mill with the VLM500-DG system	5
Figure 2: Example of a ring buffer of size 12	6
Figure 3: Position of devices	7
Figure 4: Measurement accuracy under laboratory conditions	9
Figure 5: Status page of the integrated webserver	10
Figure 6: Telnet menu to configure the UDP and TCP channel	16

Figure 7: VLMTool with new tab "DG-Option"	19
Figure 8: Tunnel mode off.....	20
Figure 9: Tunnel mode on	20
Figure 10: Reference points for process calculation.....	21
Figure 11: Sync Analyzer	24
Figure 12: cabling of VLM500-DG system	26
Figure 13: Wiring plan.....	27

IV. List of tables

Table 1: VLM500 Profinet modes (Profinet IN).....	11
Table 2: Minimum output times (all values in ms).....	12
Table 3: Adjustable VLM500-DG-Parameter via Profinet.....	12
Table 4: Device status	14
Table 5: Control byte for Profinet OUT	14
Table 6: VLM500-DG Data stream via UDP.....	17
Table 7: Profinet device status	17
Table 8: Controlbyte IFFE	18
Table 9: Format control byte TCP	18
Table 10: Setting range of the parameter SYNCBASIS.....	22
Table 11: Settings for SO2	23
Table 12: Error list.....	25

1 General information

1.1 Introduction

This manual describes the software and hardware of the VLM500 – DG skin pass measuring system. It is a supplementary manual for the VLM500 speed and length measuring gauge.

The DG system consists of up to three VLM500 devices that are wired to one another and that automatically calculate and output differential values. This system was specially developed for use in skin-pass, stretching and rolling stands in the steel and aluminum industries.

The system consists of a master VLM500 (DG master) and at least one slave (DG slave 1), as shown in Figure 1. Optionally, a second slave (DG slave 2) can be connected in order, to additionally determine the degree of stretching. The calculations of the differential values (skin-pass and stretching degree) are carried out in the DG-Master. The calculations are based on lengths, not on velocities. This leads to more accurate values, because fluctuations in speed are considered. A separate evaluation unit is not required. During the communication between the DG-Master and the DG-Slave and the calculation of the mass flow values, the busy LED in the cover of the DG-Master lights up yellow.

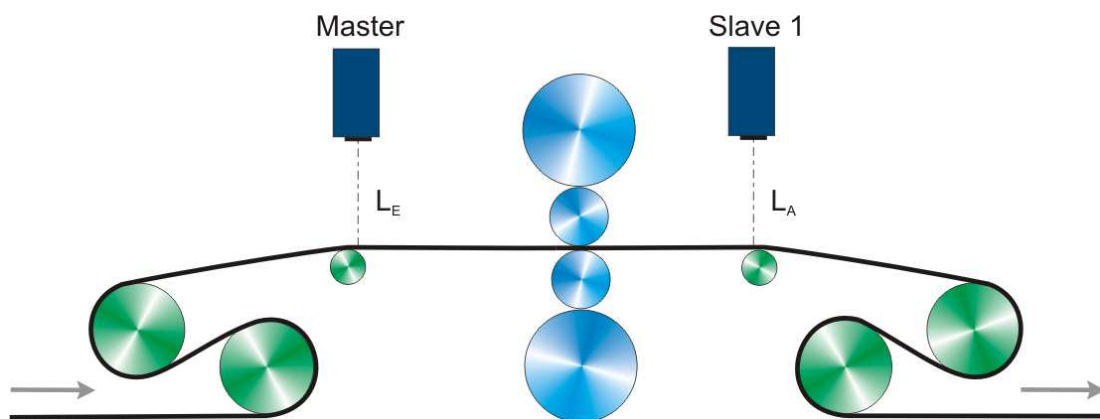

Figure 1: Principle of a skin pass mill with the VLM500-DG system

It is recommended to place the DG-master in the infeed of the system. DG-slave 1 comes to the outfeed. In case that a second slave device is installed, it is placed in the further / subsequent outfeed. The parameter "SYNCBASIS" can be used to set which device the calculated values refer to, i.e. whether they refer to the infeed or the outfeed.

For the calculation of the mass flow values, it is irrelevant whether the respective VLM500 is mounted in the direction of object movement¹ or against the direction of object movement. In the case the VLM500 is mounted reversely (against the direction of object movement), the "DIRECTION" parameter of the corresponding VLM must be adapted. If, for example, the DG master is installed reversely, the "DIRECTION" parameter must be set to the value 1 in the master. Otherwise 0. Both VLM500 are programmed to "DIRECTION 0" by default. If possible, it is recommended to install the devices in the direction of movement.

¹ direction of object movement means that the measurement object moves from the housing base to the housing cover of the VLM.

1.2 Mode of operation

Start of calculation

After all devices are connected and switched on, the "SYNCSTART" command must be executed in the DG-Master. This can be achieved in two ways: in the case of a Profinet connection, bit 2 ("SYNCSTART") must be set in the control byte (see section 2). Or the command can send to the DG slave via the programming interface. If the skin pass measurement and the optional degree of stretching measurement are to take place automatically after the devices are switched on, the parameter SYNCAUTO must be set to "1" and permanently saved in the DG-Master.

When SYNCSTART is executed, all devices connected to the master receive a start trigger pulse. As soon as the object to be measured (e.g. steel strip) starts moving, all devices record the length of the material passed in their field of vision (like a normal VLM500). If the measured length in the DG-Master is greater than or equal to the configured refresh length (command SYNCREFRESH), another trigger pulse is output synchronously to all connected devices. These save the length recorded up to that point and immediately start a new length measurement. In the meantime, the DG-Master queries the saved lengths from the slave devices one after the other. The length segments are added to the previous length values and stored in a ring memory. The integration takes place until the parameterized measurement length (command SYNLENGTH) is reached. The ring buffer is treated according the FIFO (First In First Out) principle.

Figure 2 shows an example of a circular buffer with 12 fields. With each update step, a new length element that is one refresh length longer, is inserted into the ring buffer. When the buffer is full and the oldest value is removed. The size n of the ring memory results from the quotient of the measurement length to the refresh length.

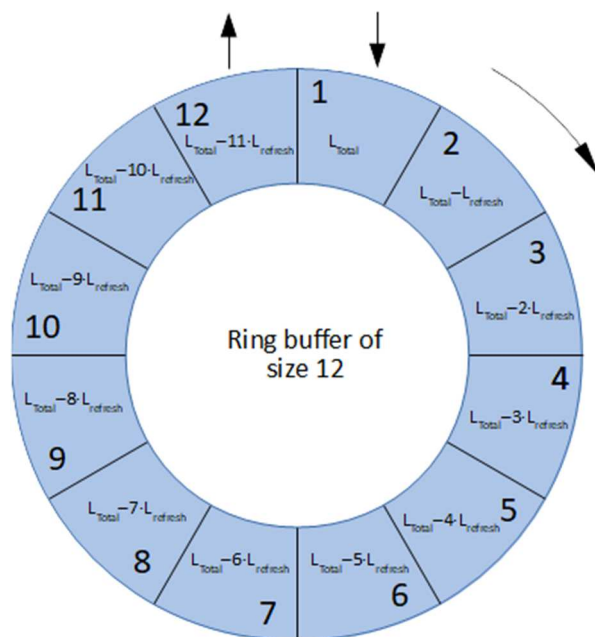

Figure 2: Example of a ring buffer of size 12



By default, the calculation of values is not active after powering up the system. By setting the parameter SYNCAUTO to 1 (in the master device), the calculation starts after power-up. This setup requires a sequential start-up where the slaves have to be powered before the DG-master. Otherwise there will be communication errors

Filter behavior of the ring buffer

The principle of the ring buffer corresponds to that of a low-pass filter. This means that changes to the skin pass characteristics are delayed by the VLM500-DG depending on the dynamics. To estimate the delay time, which is actually a length, the following simplified approach applies:

The time constant τ is used from the analysis of linear dynamic systems. τ is the time after which the response of a system has reached 63% of a sudden change at the input (step response). Translated to the VLM500-DG system, this means: τ is the length after that 63% of changes in the skin pass characteristics have been processed by the internal processor. Based on this relationship an appropriate setting of the measurement length (parameter SYNLENGTH) can be estimated by dividing the desired length by 0.63.

Example: If the user wants to see changes in the skin pass characteristics after 30m processed length, the setting for SYNLENGTH should be $30 \text{ m} : 0.63 = 47.6\text{m}$ approx. 48m.



Attention! The effect of changes in the skin pass characteristic on the material is immediate. However, the metrological acquisition is delayed.

Calculation of skin pass level and stretching degree

The total lengths L_{Master} , $L_{Slave 1}$ and $L_{Slave 2}$ are used to calculate the skin-pass or degree of stretching. The total length results from $L = L_{total} - (L_{total} - x \cdot L_{total})$. The oldest length value from the ring buffer is subtracted from the newest measured length value.

All three length values are now used to calculate the skin-pass or degree of stretching using the formula:

$$DG = \frac{L_{Master} - L_{Slave 1}}{L_{Master}} \cdot 100\%$$

$$RG = \frac{L_{Slave 1} - L_{Slave 2}}{L_{Slave 1}} \cdot 100\%$$

Where DG is the skin pass level and RG is the degree of stretching.

In this calculation DG and RG are referenced to the infeed of the mill. See Figure 3.

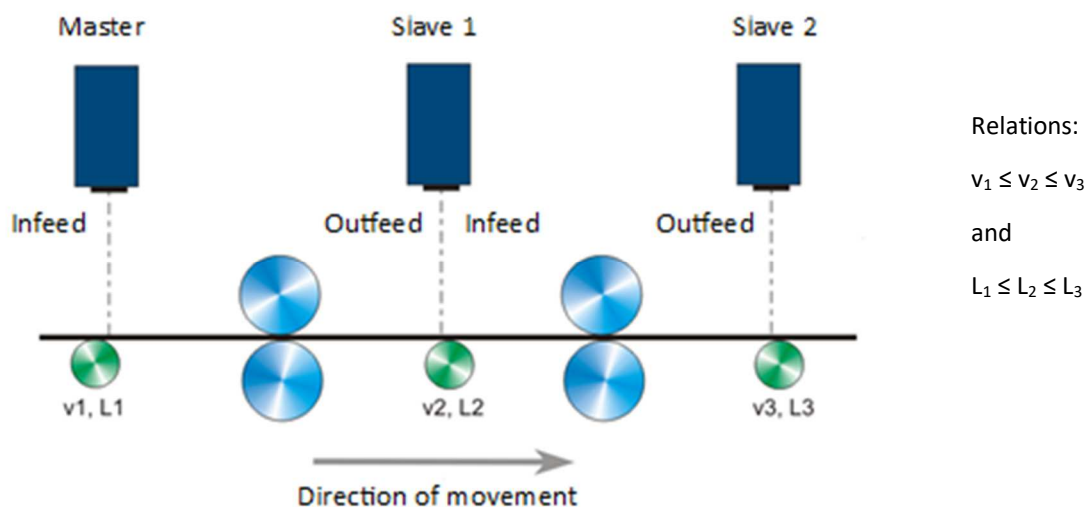

Figure 3: Position of devices

Whether the calculation will be done with reference to the in- or outfeed of the machine is controlled by the command SYNCBASIS.

While the communication between the DG-master to the DG-slaves is active and the calculation of the skin pass level is running the Busy-LED of the Master lights up yellow.

Process monitoring

There is permanent monitoring of the communication between the devices. If a DG-slave does not send the requested data to the DG-master within 500 ms, an internal communication error counter is incremented. If 10 communication errors occur in succession with a DG-slave, error E70 (for DG slave 1) or error E71 (for DG slave 2) is output on the DG-master. After that the error counter is reset. The communication error counter is also reset each time the communication with a DG-slave was successful.

The DG master also permanently monitors the lengths received from the DG-slaves. If length values are not in the expected interval of $0,5 \cdot L_{refresh} < L_{slave} < 1,5 \cdot L_{refresh}$, error E72/E73 (for DG slave 1) or error E74/E75 (for DG slave 2) is output on the DG master.

When a communication error occurs or the slave length is out of range, no new calculation of DG or RG take place. Instead the last value is output.

If there is a measurement failure of the DG-Master, the contents of the ring buffers are also deleted.

Stop of calculation

In order to end the calculation of the mass flow values in a targeted manner, the "SYNCSTOP" command has to be called. This is done via Profinet by setting bit 1 in the control byte or by sending the command to the programming interface.

In order to restart a calculation, the "SYNCSTOP" command and then the "SYNCSTART" command must always be executed. In this way the contents of the ring buffers are deleted and the calculation start restarts again.

Start of object movement

Due to its principle, a VLM500 cannot acquire the "standstill" state of a measurement object. A minimum speed is required that can be measured by the sensor. It cannot be predicted at what speed a VLM500 will start measuring. The minimum speeds specified in the datasheet are to be understood as guaranteed values from which the VLM500 can record signals in any case. In order to still be able to achieve synchronicity of the DG master and the DG slave in the event of a measurement object moving from standstill, the parameter VMIN is used. VMIN is set the same for all VLM500 devices. As soon as the DG master can measure this speed, it sends a synchronization pulse to the DG slave.

Accuracy of measurement

The absolute error of the calculation of the skin pass level is equal to the sum of the relative errors of the two measuring devices. In the data sheet of the VLM500, the relative error specified under laboratory conditions is given as $\pm 0.025\%$. Thus, the absolute error of the skin pass system is $\pm 0.05\%$. The measurement curve in the following figure shows the spread under laboratory conditions. The set skin pass level is close to zero.

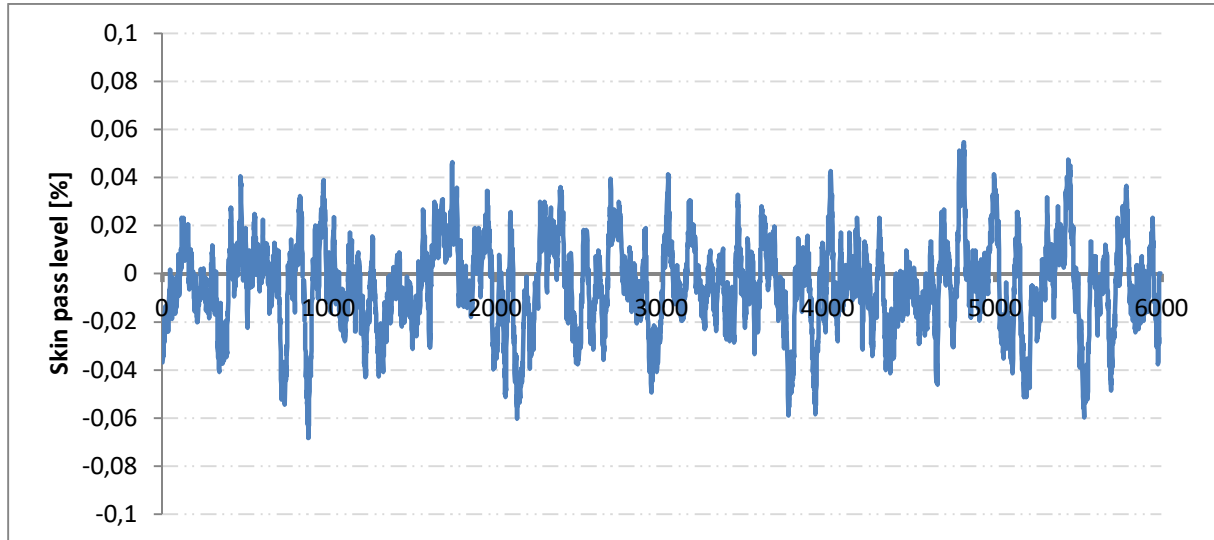

Figure 4: Measurement accuracy under laboratory conditions

The spread is approximately $\pm 0.05\%$. This distribution would also occur in the case of skin pass levels deviating from zero. The absolute error remains the same.

Under real conditions, absolute errors in the skin pass system of $\pm 0.2\%$ are to be expected for total lengths of up to 50 m. Larger skin pass levels can therefore be acquired more precisely than smaller ones because the absolute error remains the same.

2 Data transmission

2.1 Profinet

The VLM500-DG system can be equipped with a Profinet interface. The associated IFPN interface card is installed in the DG master and connects it to the network. This enables the communication between a PLC and the DG master over large distances using standardized network components. The current mass flow measured values can be output synchronously with the trigger. It is also possible to send control commands to the master via Profinet. A small webserver is also available providing a website showing status information about the measuring device.

VLM500-DG Sensor Page **ASTECH**

Profinet IO Configuration

Device Name	Vendor Name	Vendor ID	Serial number	Mode
vlm-dg-pn-0229	ASTECH GmbH	797	S/N 0500/0229/20	M6

IP Configuration

IP Address	Subnet Mask	MAC Address	Gateway Address
192.168.0.51	255.255.255.0	00-14-11-44-8E-89	192.168.0.1

Measurement Data

Skin Pass	Degree of stretching	Error	Device Status
00003132	00000000	000	000

Velocity 1	Velocity 2	Velocity 3	Length
00091890	00091430		00000245

[ASTECH Website](#)

Figure 5: Status page of the integrated webserver

Output mode

The Profinet interface is configured via the Profinet master (Profinet IO controller). Interface-specific parameters such as the IP address to be used, the subnet mask, the gateway, the name or the mode can be changed.

There are 7 modes for data exchange with the IO controller (see table 1) available. For correct communication, the data output mode set in the master must match that in the Profinet IO controller. The data output mode in the master VLM is set with the SYNCOUTPUT command. The same mode must be selected in the controller (PLC). The provided GSDML file supports all 7 modes.

Table 1: VLM500 Profinet modes (Profinet IN)

Mode	Structure	SYNCOUTPUT	Remarks on table 1
M1	16 Bit Counter 32 Bit Skin pass level 8 Bit VLM – error number 8 Bit Device status	1	The output of the numerical values via Profinet is always unsigned! The sign is coded in the status byte (see below).
M2	16 Bit Counter 32 Bit Skin pass level 8 Bit VLM - error number 8 Bit Device status 32 Bit velocity of master 32 Bit velocity of slave 1	2	Remarks on table 1 <ul style="list-style-type: none"> velocity: 0,00001 m/s,
M3	16 Bit Counter 32 Bit Skin pass level 8 Bit VLM - error number 8 Bit Device status 32 Bit velocity of master 32 Bit velocity of slave 1 16 Bit measurement rate of master 16 Bit measurement rate of slave 1	3	<ul style="list-style-type: none"> skin pass level / deg. of stretching: 0,00001 %, measurement rate: 0,1 %
M4	16 Bit Counter 32 Bit Skin pass level 8 Bit VLM - error number 8 Bit Device status 32 Bit degree of stretching	4	<ul style="list-style-type: none"> length¹⁾: 0,001 m
M5	16 Bit Counter 32 Bit Skin pass level 8 Bit VLM - error number 8 Bit Device status 32 Bit velocity of master 32 Bit velocity of slave 1 32 Bit degree of stretching	5	¹⁾ Due to the size of 32 bits, a maximum length of 4,294,967.295 m (approx. 4,300 km) can be transmitted. If this value is exceeded, the value starts counting again at 0. The internal length measurement of the VLM, however, continues up to 2 million kilometers and then jumps to 0.
M6	16 Bit Counter 32 Bit Skin pass level 8 Bit VLM - error number 8 Bit Device status 32 Bit velocity of master 32 Bit velocity of slave 1 16 Bit measurement rate of master 16 Bit measurement rate of slave 1 32 Bit degree of stretching 32 Bit processed total length ¹⁾	6	
M7	16 Bit Counter 32 Bit Skin pass level 8 Bit VLM - error number 8 Bit Device status 32 Bit velocity of master 32 Bit velocity of slave 1 32 Bit velocity of slave 2 16 Bit measurement rate of master 16 Bit measurement rate of slave 1 16 Bit measurement rate of slave 2 32 Bit degree of stretching 32 Bit processed total length	7	

Timing

The update time or minimum output time (time until new data is put on the bus) can be estimated using the formula $t = s_{refresh}/v_{object}$. Due to internal communication and data processes in the DG-master, the update time is restricted.

Table 2 shows typical configurations of SYNCREFRESH and the object speed. The minimum output time must be greater than 45 ms when operating with one DG slave or greater than 75 ms when operating with two DG slaves.

SYNCREFRESH should be adjusted or the object speed should be reduced in order to guarantee the required times. Table 2 shows permissible configurations with one DG slave in yellow and black. Permissible times for two DG slaves are shown in black. Prohibited configurations are shown in red.



If the update time is undershot, loss of data can occur.

Table 2: Minimum output times (all values in ms)

v [m/s]	SYNCREFRESH [m]								
	0,10	0,15	0,20	0,25	0,30	0,40	0,50	0,60	1,00
0,5	200	300	400	500	600	800	1000	1200	2000
1,0	100	150	200	250	300	400	500	600	1000
1,5	67	100	134	167	200	267	334	400	667
2,0	50	75	100	125	150	200	250	300	500
2,5	40	60	80	100	120	160	200	240	400
3,0	34	50	67	84	100	134	167	200	333
5,0	20	30	40	50	60	80	100	120	200
6,0	17	25	34	42	50	67	84	100	167
8,0	13	19	25	32	38	50	63	75	125
10,0	10	15	20	25	30	40	50	60	100

Parametrization via Profinet IO

The VLM500-DG-Master sensor can be parametrized upon every bus start. Selected VLM500 – parameters can be changed according to the process needs. The following table show the available adjustable parameters.

Table 3: Adjustable VLM500-DG-Parameter via Profinet

Nr.	Parameter	Range	Default value
1.	Amax	0.0 – 10.0 m/s ² (0.1 steps)	2 m/s ²
2.	Average	0 - 65535 ms (0.1 steps)	20 ms
3.	Controlhold	0 or 1	0 (off)
4.	Direction	0 ... 4, a	2 (extern, Control byte)
5.	Holdtime	First value: 10 – 65535 ms Second value: 9 - 65564 ms (Reaction Time)	250 ms 10 ms
6.	Lengthoffset	0 – 999.9999 m (0.0001 steps)	0 m
7.	Minrate	0 ... 99	0 (off)
8.	Mode	0 or 1	0 (Single)

Nr.	Parameter	Range	Default value
9.	Seltrigger	0 or 1	0 (off)
10.	Tracking	0 ... 4	2
11.	Trigger	0 ... 5	0 (High level)
12.	Vmax	0.01 – 100 m/s (0.01 steps)	4 ms/s
13.	Vmin	0.0000 – 100 m/s (0.0001 steps)	0 m/s
14.	Window	1 ... 32	8
15.	PO1Factor (Sign)	+ or -	+
	PO1Factor (value)	0.1 – 2500 (0.1 steps)	1
16.	PO1On	0 or 1	0 (off)
17.	P01Sync	0 or 1	0 (Average)
18.	PO2Factor (sign)	+ or -	+
	PO2Factor (value)	0.1 – 2500 (0.1 steps)	1
19.	PO2On	0 or 1	0 (off)
20.	P02Sync	0 or 1	0 (Average)
21.	PO3Factor (sign)	+ or -	+
	PO3Factor (value)	0.1 – 2500 (0.1 steps)	1
22.	PO3On	0 or 1	0 (off)
23.	P03Sync	0 or 1	0 (Average)
24.	VLM parameter	0 or 1	0
25.	SO2Format	DG-M1 ... DG-M6	DG-M6
26.	SO2Time	1 – 65535 ms	30 ms
27.	SO2Sync	0 or 1	0 (time)
28.	LBCD1	0 – 999.9999 m (0.0001 steps)	0 m
29.	LBCD2	0 – 999.9999 m (0.0001 steps)	0 m
30.	LBCD3	0 – 999.9999 m (0.0001 steps)	0 m
31.	LBCD4	0 – 999.9999 m (0.0001 steps)	0 m
32.	LBCD5	0 – 999.9999 m (0.0001 steps)	0 m
33.	LBCD6	0 – 999.9999 m (0.0001 steps)	0 m
34.	LBCD7	0 – 999.9999 m (0.0001 steps)	0 m
35.	LBCD8	0 – 999.9999 m (0.0001 steps)	0 m
36.	LBCDOn	0 or 1	0 (off)
37.	OED	0 or 1	0 (off)
38.	SYNCOOUTPUT	0 or 1	0
39.	SYNCBASIS	0 or 1	0
40.	SYNCCALC	0 or 1	0
41.	SYNCLENGTH	50000...500000	100000
42.	SYNCREFRESH	500...200000	2000

Digits of precision will be entered with integer values. Example: to set VMAX to 4.55 m/s the input of a value of 455 is necessary.

If the parameter no. 24 "VLM parameter" is set to 1 the selected parameters are transmitted from the Profinet Master to the VLM500DG at every startup of the Profinet system or restart of the VLM500DG. The parameter setup loaded from the internal memory of the VLM will be overwritten with the parameters from the Profinet master.

If parameter no. 24 "VLM parameter" is left to "0" no parameters will be transmitted to the VLM500DG. The sensor will use the currently loaded parameter set from the internal memory.

In case an error occurred during bus parametrization, all subsequent will be discarded by the VLM. It is therefore recommended to check the success of the parametrization for new configurations using the "Parameter Response" output channel. An error is indicated by the parameter number followed by the error code. Example: 240004 is error E04 at parameter 24.

Device status

In every mode the device status is transmitted as a byte. The single bits have the following meaning:

Table 4: Device status

Bit 7 - 5	Bit 4	Bit 3	Bit 2	Bit 1	Bit 0
<reserved>	sign of RG	Sign of DG	sign of velocity Master	sign of velocity Slave	Status of output ERROR
	0 ... positive 1 ... negative	0 ... positive 1 ... negative	0 ... positive 1 ... negative	0 ... positive 1 ... negative	

Control byte (Profinet OUT)

In addition to the data transmission from the DG-master to the Profinet IO controller, the DG-master can be controlled by the Profinet IO controller. A control byte is available for this. By setting individual bits, specific events can be triggered in the DG master. The meaning of the individual bits is as follows:

Table 5: Control byte for Profinet OUT

Bit	Meaning	Type	Remark
0	Standby	Level	LOW- level: <nothing> HIGH- level: Standby
1	Syncstop	Edge	rising edge: stop calculation falling edge: < nothing >
2	Syncstart	Edge	rising edge: start calculation falling edge: < nothing >
3	Restart	Edge	rising edge: device restart falling edge: < nothing >
4	Error	Edge	rising edge: reset VLM errors falling edge: < nothing >
5	Length measurement	Level	LOW- level: no length calculation, HIGH- level: length calculation active
6 ¹⁾	Parameter set	Level	LOW- level: VLM-Parameter set 0 HIGH- level: VLM-Parameter set 1
7	Enable Restore	Edge	rising edge: loads the parameter set defined by bit 6 falling edge: < nothing >

¹⁾ Bit 6 is only processed by the VLM if bit 7 is set to HIGH

2.2 Ethernet

The VLM500-DG system can be equipped with an Ethernet interface. The IFFE interface card connects the DG master to an Ethernet network. This enables communication between evaluation units like a PLC and the measuring device over large distances using standardized network components.

By using Telnet, the Ethernet interface can be used like the programming interface of the device when the connection is active. The same command syntax is used for parameterization. The current measured values can be output permanently and trigger-synchronously.

In addition, the IFFE offers a UDP channel for the transmission of measurement data to a freely selectable destination address in the network. A TCP channel is also available, which can be reached from anywhere in the network. This type of transmission is particularly suitable for recording the measured values of the VLM500.

A very helpful function when setting up and monitoring the VLM500-DG with Ethernet interface is the search for the measuring devices available in the network via a specified UDP broadcast.

By default, the device has the IP address: 192.168.000.051 and the subnet mask: 255.255.255.000. If this address is not available, a P2P connection must be established in order to change the address via the Telnet client.

Communication

- General settings of the serial interface SO2 in the DG-master
 - Serial interface SO2 of the VLM must be set to defined parameters
 - Speed setting: *SO2Interface 57600 N D*
 - To guarantee an ongoing data output: *SO2ON 1*
 - The output interval is synchronous with the refresh length: *SO2SYNC 1*
 - The output format is: *SO2FORMAT G and SYNCOUTPUT 6*
- UDP
 - One UDP channel for the output of the current measured values
 - Freely selectable configuration of destination IP address and port number
 - A separate UDP channel for searching for devices in the network via broadcast telegram
 - Listen-Port of VLM500 = 33003
 - Identification for ASTECH-devices = 0x05
 - Response data: type, version, serial number, IP-address, MAC-address, connection status
- TELNET
 - Service related 8-bit ASCII communication via TCP/IP
 - Client is establishing the connection
 - Listen-Port = 23
 - Command syntax the same as with the programming interface
 - Use of conventional Telnet client programs is possible (e.g. ASTECH Ethertool or third-party application like Hterm)
 - Only one connection possible at the same time
 - Password protected access by default
 - Standard password: „wega“, can be changed via TELNET
 - Configuration mode for the parameter of the IFFE interface

- TCP
 - One TCP/IP channel for the output of the current measured values
 - Device acts as a server and can be accessed from anywhere on the network
 - Standard port of VLM500 = 33005
 - IP-address is the same as the VLM500 address
 - Port can be changed via TELNET



The SO2 interface for outputting the measurement data is activated by default. If you log in via TELNET, the raw data sent by the VLM are visible. To change VLM parameters or to use the configuration mode, we recommend deactivating the interface with the SO2ON 0 command. However, the communication of the individual channels is temporarily deactivated! When exiting configuration mode, the SO2 interface is automatically reactivated.

Configuration of the UDP/TCP-data transmission

The UDP and TCP are configured in a separate configuration mode via TELNET. Interface-specific parameters, such as the IP address to be used and the subnet mask, can be changed using simple menu. It is also possible to protect the TELNET connection against unauthorized access with the help of a password. To enter the configuration mode via the normal TELNET connection simply enter the # character. The TELNET connection can now be used, to set up the two channels.



The input of the data for the channels must always correspond to the following format:
 IP-Address: xxx.xxx.xxx.xxx
 Port number: xxxxx

```
[Information]
Type       : ULM500E
S/N        : 0500/0191/19
IP Address  : 192.168.0.51
Subnet Mask : 255.255.0.0
MAC Address : 00-14-11-84-E7-B3
Software    : U1.0 DG
UDP IP      : 192.168.0.13
UDP Port    : 33003
Enable UDP (0-No 1-Yes) : 1
TCP Port    : 33005
Enable TCP (0-No 1-Yes) : 0

[Selection]
1 - Set IP Address of Device
2 - Set Subnet Mask of Device
3 - Set Password for Telnet
4 - Edit UDP Channel
5 - Edit TCP Server
6 - Edit ON/OFF
7 - Reboot
8 - Quit
```

Figure 6: Telnet menu to configure the UDP and TCP channel



When the IFFE module software is updated, the password for the Telnet connection is overwritten regardless if it is used or not. It is therefore strongly recommended that the manufacturer accompanies the update process.

After setting up all parameters and settings, the following data stream can be streamed via the UDP interface.

Table 6: VLM500-DG Data stream via UDP

Size	Value	Data field
16 Bit	Counter	1
32 Bit	Skin pass level	2
8 Bit	Error (DG-master)	3
8 Bit	Device status	4
32 Bit	Velocity of master	5
32 Bit	Velocity of slave 1	6
16 Bit	Measurement rate of master	7
16 Bit	Measurement rate of slave	8
32 Bit	Degree of stretching	9
32 Bit	Processed total length	10

The output of the numerical values via Profinet is always unsigned! The sign is coded in the status byte (see below).

The scaling factors of the different values are:

- velocity: 0,00001 m/s,
- skin pass level / degree of stretching: 0,00001 %,
- measurement rate: 0,1 %,
- length²: 0,001 m.

All values are absolute values! The sign of the velocity and length values are included in the device status byte.

Device status

The fourth data field (one byte) transmits the device status. The single bits have the following meaning:

Table 7: Profinet device status

Bit 7 - 5	Bit 4	Bit 3	Bit 2	Bit 1	Bit 0
<reserved>	sign of RG	Sign of DG	sign of velocity Master	sign of velocity Slave	Status of output ERROR
	0 ... positive 1 ... negative	0 ... positive 1 ... negative	0 ... positive 1 ... negative	0 ... positive 1 ... negative	

² Due to the size of 32 bits, a maximum length of 4,294,967.295 m (approx. 4,300 km) can be transmitted. If this value is exceeded, the value starts counting again at 0. The internal length measurement of the VLM, however, continues up to 2 million kilometers and then jumps to 0.

Control byte (can only be used with TCP)

The TCP control byte has the same structure and meaning like the Profinet control byte.

Table 8: Controlbyte IFFE

Bit	Meaning	Type	Remark
0	Standby	Level	LOW- level: <nothing> HIGH- level: Standby
1	Syncstop	Edge	rising edge: stop calculation falling edge: < nothing >
2	Syncstart	Edge	rising edge: start calculation falling edge: < nothing >
3	Restart	Edge	rising edge: device restart falling edge: < nothing >
4	Error	Edge	rising edge: reset VLM errors falling edge: < nothing >
5	Length measurement	Level	LOW- level: no length calculation, HIGH- level: length calculation active
6 ¹⁾	Parameter set	Level	LOW- level: VLM-Parameter set 0 HIGH- level: VLM-Parameter set 1
7	Enable Restore	Edge	rising edge: loads the parameter set defined by bit 6 falling edge: < nothing >

¹⁾ Bit 6 will only be processed if Bit 7 will be set to 1 at the same time (see manual VLM500).

To prevent unauthorized and unintentional access to the device by the control byte, it must be sent in the following format:

Table 9: Format control byte TCP

Byte 1	Byte 2	Byte 3
character „*“ (0x2A)	Control byte	character „EOF“ (0x04)

3 Programming

The devices of the VLM500-DG system are programmed with the VLMTool. It is running under Microsoft Windows. This application is provided by ASTECH for free. After setting up the right communication port in the program options the VLMTool detects the connected VLM500-DG system. The DG system supports a group of additional commands and parameters. The VLMTool shows a special tab for the parameters as shown in the screenshot (Figure 7).

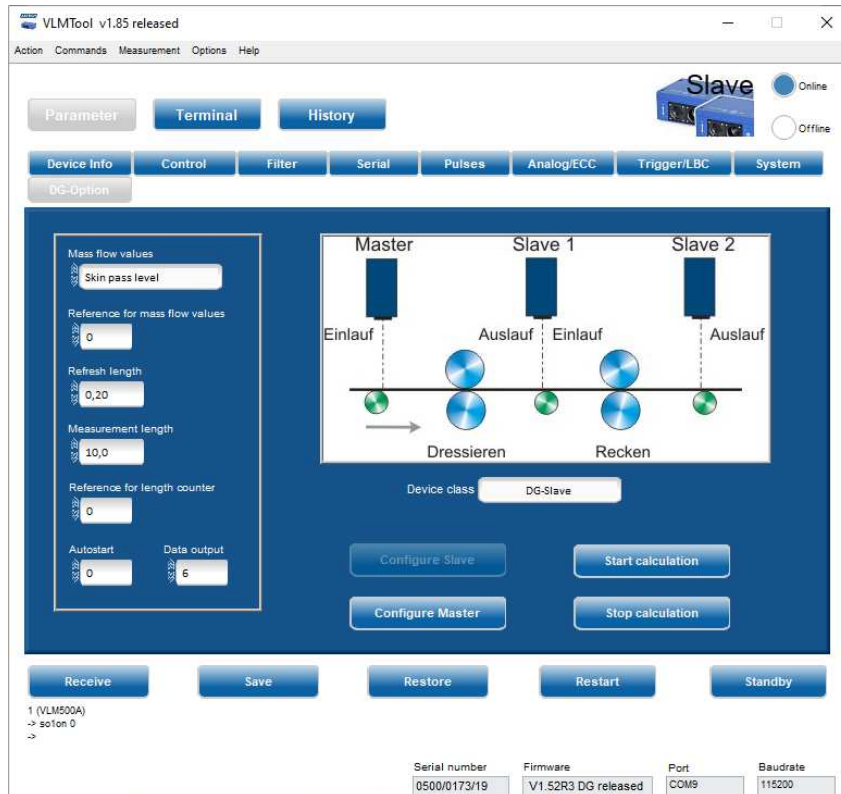

Figure 7: VLMTool with new tab "DG-Option"

The VLM500-DG system is a combination of two single VLM500 devices. Both gauges have their own parameter set which can be changed by the user. However, there is only one programming interface available. It is located in the slave device.

To guarantee the parametrization of the DG-master, a special communication mode was added to the software. When powering up the system the connected PC or notebook is always communicating with the DG slave device (see Figure 8). With the command "COMSLAVE" the DG-slave can be put into a tunnel mode. Now all commands and parameters will be forwarded directly to the DG-master and will be processed there (see Figure 9).

The active tunnel mode can also be identified by the cover LEDs of the slave case. Only the two direction LEDs light up.

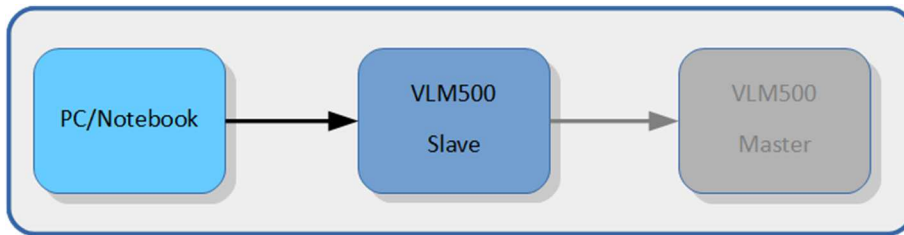

Figure 8: Tunnel mode off

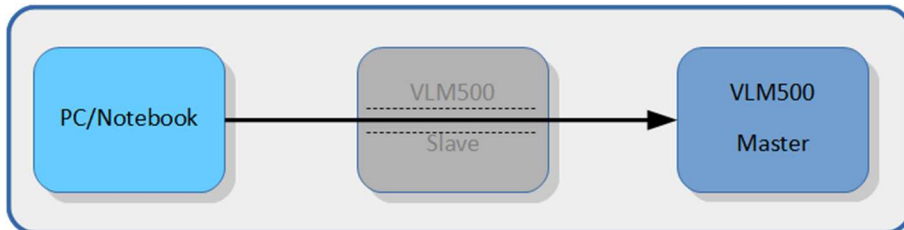

Figure 9: Tunnel mode on

The tunnel mode can also be controlled by using the respective buttons of the VLMTool. To activate the tunnel mode button “Configure Master” must be pressed. This button now is inactive and the button “Configure Slave” is active to get back to the slave by quitting the tunnel mode.



Any parameter changes inside the DG-master need to be stored permanently, before the tunnel mode will be left. Otherwise these changes will be discarded.

When the VLM500-DG system is in progress there is a permanent data exchange between the master and the slave(s). When the user wants to change parameters inside the master by activating the tunnel mode, the DG-system is not working as long as the tunnel mode is active. In fact, it is mandatory to stop the process to guarantee a stable tunnel mode.



It is strongly recommended to use the VLMTool for parameterizing the gauges and to activate and deactivate the tunnel mode.

Comslave

The command is used to set up a direct communication channel (tunnel mode) between the DG-slave and the DG-master. In principle, the DG-master does not have a communication interface for connecting a PC or notebook. In order to still be able to parameterize the DG master, a communication channel can be established via a DG slave.

Syntax: **Comslave**

After entering this command, you can communicate directly with the DG-Master. All commands entered are then received by the DG-Master and acknowledged accordingly. The LED indicators at the top cover of the slave will show the active tunnel by lighting both direction indicators.

When using two connected DG-slave devices and one DG-master the communication tunnel can be established from both slaves to the master, but there is no tunnel mode between the two slaves available.

The communication channel is ended by sending the ASCII character 0x0F ((ASCII-Code *Shift In*) to the DG-master. There is a corresponding button in the VLMTool. Alternatively, the power supply for the device can be interrupted to terminate the communication channel.



Before calling “comslave”, the command “syncstop” must be called. This ends the skin pass calculation in the master. Only then is communication from the PC to the master possible.

Sync

The command reads all information which are relevant for the synchronous operation. In addition to the parameter settings there is also an indication of whether the current device is a DG master or DG slave.

Syntax: **Sync**

The type of each device is preset (by the manufacturer) and cannot be changed by the customer!

Syncauto

This parameter sets the automatic start of the skin pass level and degree of stretching calculation at system start-up.

Syntax: **Syncauto [n]** (n = 0: off, n = 1: on)



For a correct mass flow calculation, the DG-slave has to be powered up before the DG-Master. This requirement is not applicable if the measurement object stands still.

The setting is irrelevant if the device is a DG-slave.

Syncbasis

This parameter sets the reference device (infeed or outfeed) for the skin pass level and degree of stretching calculation.

Syntax: **Syncbasis [n]** (n = 0, 1, 2 or 3)

The setting is irrelevant if the device is a DG-slave.

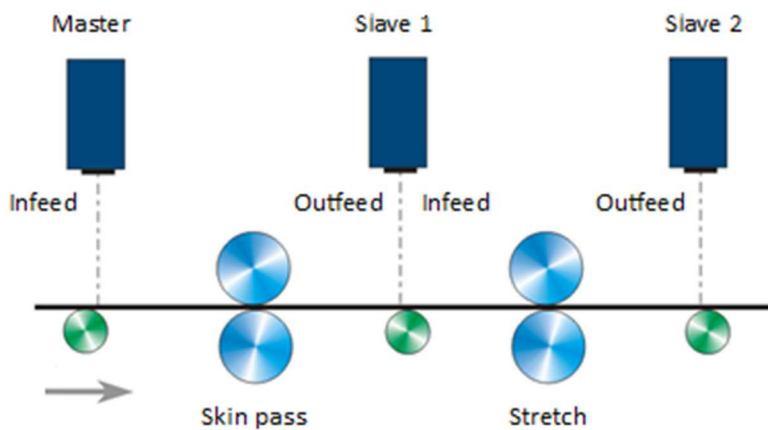

Figure 10: Reference points for process calculation

Table 10: Setting range of the parameter SYNCBASIS

Value	Meaning
0	Calculation of the skin pass level based on the infeed (master) Calculation of the degree of stretching based on the infeed (slave 1)
1	Calculation of the skin pass level based on the outfeed (slave 1) Calculation of the degree of stretching based on the outfeed (slave 2)
2	Calculation of the skin pass level based on the infeed (master) Calculation of the degree of stretching based on the outfeed (slave 2)
3	Calculation of the skin pass level based on the outfeed (slave 1) Calculation of the degree of stretching based on the infeed (slave 1)

Synccalc

This parameter sets which process values are calculated. Setting the parameter to “0” only the skin pass level is calculated. Setting the parameter to “1” both skin pass level and degree of stretching are calculated.

Syntax: **Synccalc** [n] (n = 0 or 1)



If the parameter is set to 1 and there is only one DG-slave in the system, error E71 is generated because there is no communication between DG-master and DG-slave 2.

The setting is irrelevant if the device is a DG-slave.

Synclength

This parameter sets the measurement length for the calculation of the skin pass level and/or degree of stretching.

Syntax: **Synclength** [n] (n = 5 ... 50 in m)

The quotient of Synclength and the parameter Syncrefresh defines the size of the calculation buffer (ring buffer). The right setting for this parameter must be made considering the dynamics of the skin pass mill. Synclength must be larger than Syncrefresh!

The setting is irrelevant if the device is a DG-slave.

Syncodo

This parameter sets the reference for the total length calculation done in the master.

Syntax: **Syncodo** [n] (n = 0 ... 1, 0 ... Master, 1 ... Slave 1)

The setting is irrelevant if the device is a DG-slave.

Syncoutput

This parameter sets the mode of data output to the data interface.

Syntax: **Syncoutput** [n] (n = 1 ... 7)

If the data interface is Profinet, any mode can be selected.

Table 1 shows the different output modes. If the data interface is Ethernet, mode 6 is mandatory.

This parameter does not activate the actual data output! This must still be done using the commands of the SO2 command group (see VLM500 user manual). The following overview shows the required settings for the SO2 command group.

Table 11: Settings for SO2

Parameter	Setting*
SO2ADDRESS	0
SO2SYNC	1 (Data output takes place synchronously with the calculation of new values)
SO2TIME	The setting is irrelevant.
SO2FORMAT	g
SO2INTERFACE	57600
SO2ON	1 (activates the data output to the PLC)

* The parameters are set ex works according to the table.

The setting is irrelevant if the device is a DG-slave.

Syncrefresh

This parameter sets the refresh length used to calculate the skin pass level and the degree of stretching. Each time the refresh length is reached, a new length value is put into the ring buffer, the process values are calculated and are fed to the data interface.

Syntax: **Syncrefresh** [f] (f = 0.1 ... 20.0 in m)

The quotient of this parameter and the parameter *Syncrefresh* define the size of the calculation buffer (ring buffer). *Syncrefresh* must be smaller than *Synclength*.

The setting is irrelevant if the device is a DG-slave.

Syncstart

Calling up this command starts the skin pass and degree of stretching calculation.

Syntax: **Syncstart**

Syncstate

This command reads the type of the device. If it is a master the response is "1". In case of a slave the response is "0".

Syntax: **Syncstate**

In the VLM500-DG system, one device must be a master and at least one device must be a slave. Process values can only be calculated if a DG-master and a DG-slave are set correctly.

Syncstop

Calling up this command stops the skin pass and degree of stretching calculation.

Syntax: **Syncstop**

It is mandatory to call this command before entering the tunnel mode!

4 Test mode

The test mode can be used to visualize the process values without the need of a connected processing unit (e.g. PLC) to the master. When the test mode is active all relevant values are shared to the programming interface of the slave device. The VLMTTool can be used to run the test mode. In the VLMTTool the function “Sync Analyzer” must be started to run the test mode.

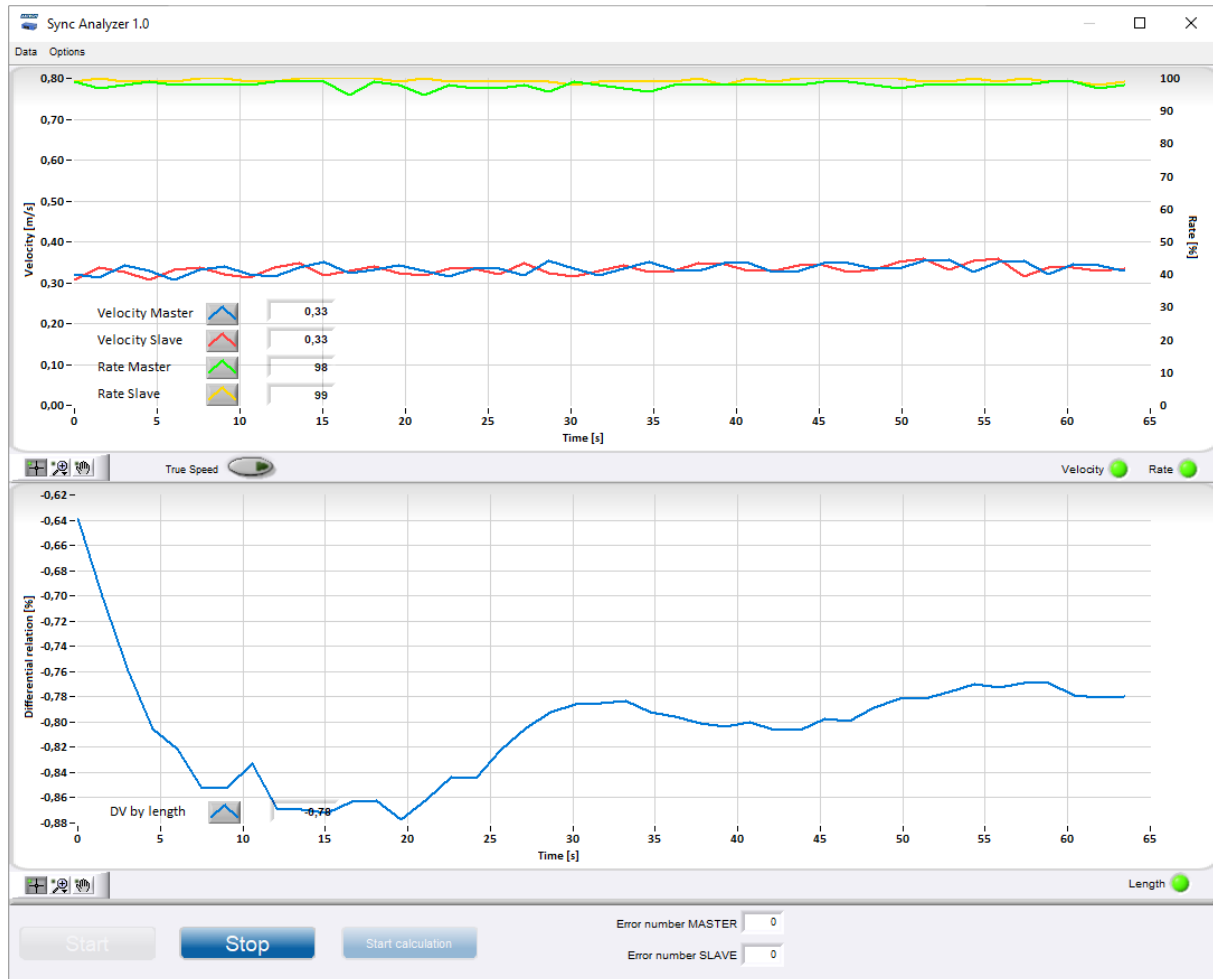

Figure 11: Sync Analyzer

To record a measurement, the button “Start calculation” must be clicked first. After that the button “Start” must be clicked. To stop the data acquisition, click the “Stop” button.

5 Error messages

In addition to the normal VLM error codes, the DG option provides Table 12.

Table 12: Error list

Code	meaning	Cause of error
E70 SLAVE 1 communication defective	Missing communication between master and slave 1.	The master did not receive an answer from slave 1 for 10 times.
E71 SLAVE 2 communication defective	Missing communication between master and slave 2.	The master did not receive an answer from slave 2 for 10 times.
E72 SLAVE 1 length too short	The refresh length L_{refresh} of slave 1 is more than 50% shorter than the master value. The value is discarded.	The measurement conditions for slave 1 are insufficient. A correct length acquisition is not guaranteed.
E73 SLAVE 1 length too long	The refresh length L_{refresh} of slave 1 is more than 50% longer than the master value. The value is discarded.	The measurement conditions for the master are insufficient. A correct length acquisition is not guaranteed.
E74 SLAVE 2 length too short	The refresh length L_{refresh} of slave 2 is more than 50% shorter than the master value. The value is discarded.	The measurement conditions for slave 2 are insufficient. A correct length acquisition is not guaranteed.
E75 SLAVE 2 length too long	The refresh length L_{refresh} of slave 2 is more than 50% longer than the master value. The value is discarded.	The measurement conditions for the master are insufficient. A correct length acquisition is not guaranteed.
E76 MASTER length zero	The last length element of the master is zero. The value is discarded.	Internal error of length calculation.
E77 SLAVE 1 length zero	The last length element of slave 1 is zero.	Slave 1 cannot measure.
E78 SLAVE 2 length zero	The last length element of slave 2 is zero. The value is discarded.	Slave 2 cannot measure.

When analyzing the errors, the installation position of the master and slave in relation to the material movement must be considered. (see Figure 3)

6 Device cabling

The following figure shows the wiring of the VLM500-DG system. The interconnection takes place in the form of a chain. The slave devices are identical and can be interchanged. Only the parameterization has to be adapted.

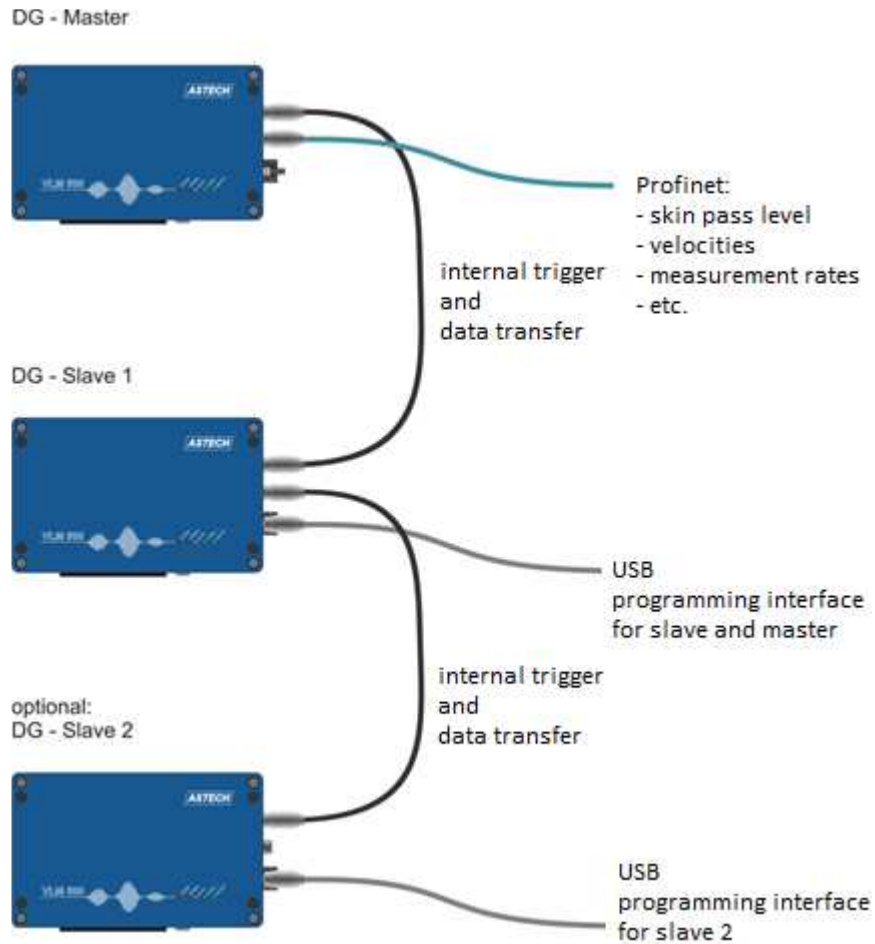

Figure 12: cabling of VLM500-DG system

7 Wiring plan

The devices are wired to one another according to a fixed scheme. Refer Figure 13.

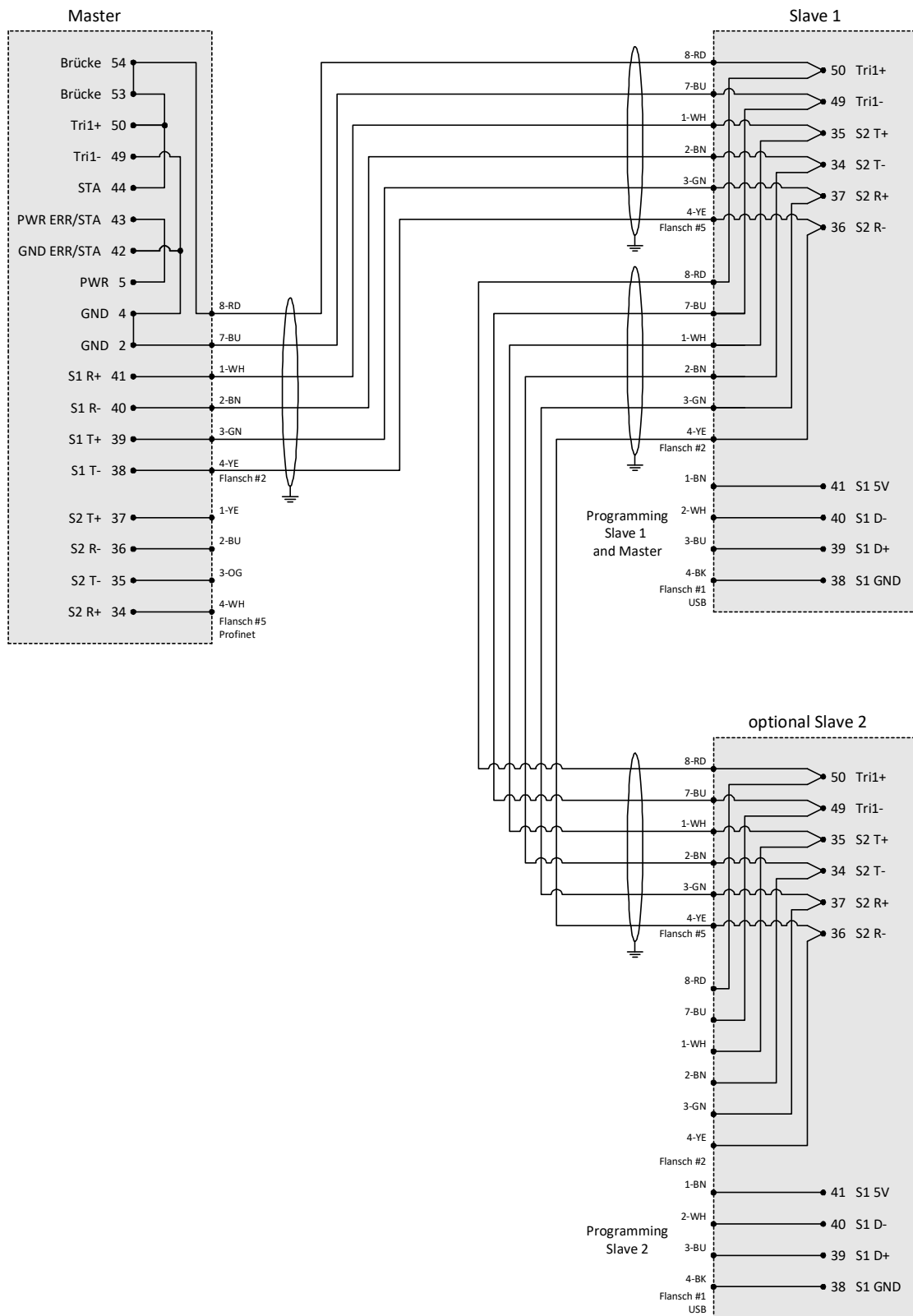

Figure 13: Wiring plan